

40-krad/s Polarization Tracking in 200-Gb/s PDM-RZ-DQPSK Transmission Over 430 km

Benjamin Koch, *Student Member, IEEE*, Reinhold Noé, *Senior Member, IEEE*, Vitali Mirvoda, David Sandel, *Member, IEEE*, Volker Filsinger, and Kidsanapong Puntsri

Abstract—We present real-time transmission of 50-Gbaud polarization-division-multiplexed (PDM) return-to-zero differential quadrature phase-shift keying (4 bit/symbol) over five fiber spans, 430 km in total. The two PDM channels are demultiplexed using a beam splitter and automatic optical polarization control with interference detection. For the first time, PDM signal tracking speeds of up to 40 krad/s are demonstrated.

Index Terms—Optical fiber communication, optical fiber polarization, quadrature phase-shift keying (QPSK).

I. INTRODUCTION

COHERENT receivers of polarization-division-multiplexed quadrature phase-shift-keying (PDM-QPSK) transmission systems have demonstrated effective compensation of linear distortions. On the other hand, their high-speed digital signal processing is power-greedy and requires great development effort. Until now, coherent real-time PDM-QPSK receivers have been demonstrated for up to about 50 Gb/s (gross) [1] per optical carrier. Higher bit rates are accessible only with offline processing [2], [3]. Since many transmission links are chromatic dispersion (CD) compensated and have just moderate polarization-mode dispersion (PMD), interferometric direct detection of differential QPSK (DQPSK) can be more efficient for these cases. Real-time PDM-DQPSK transmission has already been demonstrated for bit rates up to 200 Gb/s [4].

Endless optical polarization control is a key component for PDM-DQPSK receivers. We have developed such a control system, capable of tracking 56-krad/s polarization changes of an unmodulated laser source [5], [6] by intensity minimizing. Mean and worst polarization errors in a 50-Gigardian-long trajectory tracked at up to 50 krad/s [6] are 0.066 and 0.195 rad, respectively. In many recent publications, polarization control is either seemingly slow [7]–[9] or manual [10], [11]. We have recently transmitted 112 Gb/s while tracking 800 rad/s [12] and 200 Gb/s while tracking 10 krad/s [4], both with interference detection [7]. Here we demonstrate, by quadrupling the tracking speed, that tracking speeds in intensity minimizing and interference minimizing experiments need not differ fundamentally.

Manuscript received December 22, 2009, revised January 29, 2010; accepted February 08, 2010. Date of publication February 22, 2010; date of current version April 02, 2010. This work was supported in part by Deutsche Forschungsgemeinschaft and Bundesministerium für Wirtschaft und Technologie.

B. Koch, R. Noé, V. Mirvoda, D. Sandel, and K. Puntsri are with University of Paderborn, EIM-E, 33098 Paderborn, Germany (e-mail: koch@ont.upb.de; noe@upb.de; mirvoda@ont.upb.de; sandel@ont.upb.de; puntsri@ont.upb.de).

V. Filsinger is with SHF Communication Technologies AG, 12277 Berlin, Germany (e-mail: filsinger@shf.de).

Color versions of one or more of the figures in this letter are available online at <http://ieeexplore.ieee.org>.

Digital Object Identifier 10.1109/LPT.2010.2043252

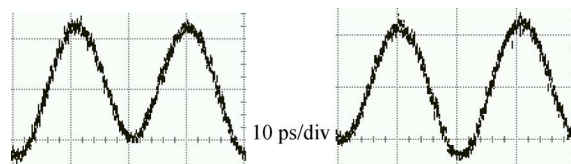

Fig. 1. Received intensity modulation (64-fold averaged) for the two polarization channels (while clock recovery PLL stays locked).

II. SETUP

A 50-GHz synthesizer clocks a 50-Gbaud bit pattern generator (SHF12100B) (see Fig. 4). The data signal and its complementary version, delayed by 12 symbols, drive a (D)QPSK transmitter (SHF46214A), with a 1553-nm, 12-dBm laser as optical source. An erbium-doped fiber amplifier (EDFA) reamplifies the signal. The 25-GHz half-rate clock of the bit pattern generator drives a subsequent Mach-Zehnder modulator. Return-to-zero (RZ) pulses which alternate the sign of every other symbol (carrier-suppressed RZ) are thereby impressed on the DQPSK signal. Finally, the 100-Gb/s RZ-DQPSK signal is passed through a 3-dB coupler. One branch signal is delayed by a couple of nanoseconds, and both are multiplexed with orthogonal polarizations. The clock frequency is fine-tuned (49.936 GHz) so that the delay is an odd number of symbols, which helps in diagnosis (see Fig. 1).

For testing purposes, the 200-Gb/s signal is passed through a polarization scrambler. It consists of two arrays (1, 2) with four rotating fiber-optic quarterwave plates (QWPs) each, and in between an electrooptic halfwave plate (HWP). Optionally, another QWP array (0) and a first-order PMD element are inserted before QWP array 1.

The signal is transmitted in five spans (launch power: +3 dBm, length 80,...,89 km) over a total of 430 km of fiber (standard single-mode fiber: 170 km; nonzero dispersion-shifted fiber: 260 km). Dispersion-compensating fiber (DCF) modules (about -3200 ps/nm in total) are inserted midway in double-stage EDFAs. There is no Raman pumping. At the receive end, the signal is attenuated to set the optical signal-to-noise ratio, and preamplified in two EDFAs. We reject noise in available cascaded dense wavelength-division-multiplexing channel filters with a combined bandwidth of 116 GHz. Residual CD is compensated in some more DCF (-40 ps/nm). For polarization demultiplexing, we have developed an endless polarization controller which drives a commercial LiNbO₃ device. It is followed by a polarization beam splitter (PBS). At its outputs, the two polarization channels are available. At one output some power is tapped off for a 10-Gb/s photoreceiver. If polarization channels are not perfectly demultiplexed, they

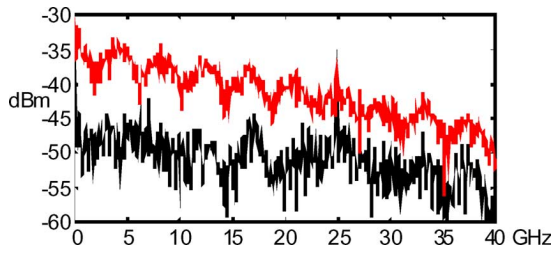

Fig. 2. Interference spectra for worst case (top) and best case (bottom).

interfere. Interference is measured in a radio-frequency (RF) power detector. A gradient descent algorithm, running on a field-programmable gate array, is programmed to minimize interference by applying appropriate electrode voltages to the LiNbO₃ device.

The demultiplexed output signal is once more optically amplified, then split into three equal portions (9 dBm each). One branch signal is detected in a D(Q)PSK photoreceiver (SHF47210A). Its output signal drives an error analyzer (SHF11100B). Another branch signal is detected in a 45-GHz photodiode. The RZ modulation generates a 50-GHz sinewave there. A clock recovery phase-locked loop (PLL) is set up with a fourth-harmonic mixer, a 12.5-GHz voltage-controlled oscillator, a loop filter, and a frequency doubler from 12.5 to 25 GHz. The recovered 25-GHz signal is connected to the error analyzer in the halfrate clock mode. The third branch with one more 45-GHz photodiode allows observing intensity modulation.

III. RESULTS

Fig. 1 shows the detected intensity modulation of one of the demultiplexed PDM channels, with averaging. Two traces are shown. After recording the first trace, polarization control was switched OFF. When it was switched ON again, the controller locked to the other channel. The clock recovery PLL stayed locked. Both traces show the 50-GHz RZ modulation. But they differ by the phase of the parasitic 25-GHz subharmonic, which allowed us to identify the received polarization channel. The traces show the intensity modulation for perfectly aligned polarization. Interchannel interference appears as RF noise superposed on the RZ modulation. It can, therefore, be monitored in the signal spectrum below 50 GHz, shown in Fig. 2. Two traces are plotted, for worst case (manually adjusted) and best case (polarization controller switched ON). The contrast is on the order of 10 dB. The periodicity is due to the 12 symbol delay between in-phase and quadrature (*I* and *Q*) data. The parasitic 25-GHz component is also seen.

Fig. 3 shows the received DQPSK eye diagrams, back-to-back and after 430 km. Either of the decorrelated *I* and *Q* data streams could be selected by changing the heating current of the interferometer in the D(Q)PSK receiver. Both polarization channels and both quadratures were demultiplexed successfully. Pseudorandom bit sequences (PRBS) were synchronized manually, so that unwanted slipping of the polarization channel would be indicated by an error overflow.

Two different demultiplexing options were tested, using the two positions of the optical switch in Fig. 4: Either DQPSK and interference detection receivers were connected to the same PBS

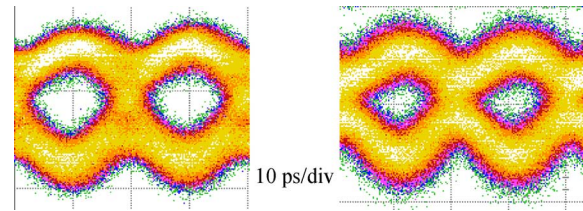

Fig. 3. DQPSK eyes back-to-back (left) by mistake/negligence recorded with 26- rather than 50-GHz scope bandwidth; (right) after 430 km.

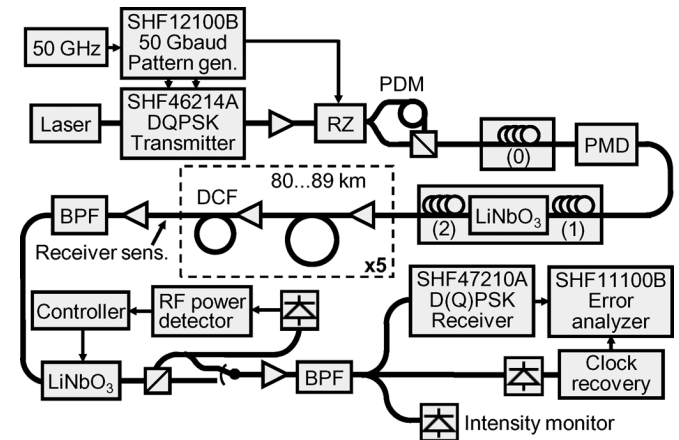

Fig. 4. The 200-Gb/s PDM-RZ-DQPSK transmission setup.

output port, or to different ones. Both options showed similar results, with both polarization channels. So, one polarization control system sufficed to demultiplex both polarization channels. This also indicates that polarization-dependent loss was small. Surprisingly, bit-error-ratio (BER) performance was sometimes better by half a decade when DQPSK and interference detection receivers were connected to different PBS ports, which could depend on link PMD.

PRBS of sizes $2^7 - 1$, $2^{11} - 1$, and $2^{15} - 1$ were transmitted, with sensitivity differences of a few 1/10 dB and a back-to-back Q^2 value of 23 dB. Back-to-back sensitivity at BER = 10^{-4} was -30.5 dBm before preamplification. Due to memory size restrictions in the real-time mode of the error analyzer, we selected the $2^{11} - 1$ PRBS for the following.

The first experiments were conducted back-to-back when the BER was degraded to about 10^{-4} by noise loading, assuming the presence of a forward-error correction. PMD tolerance was tested by placing QWP array 0 and diverse PMD elements into the PDM-DQPSK setup. By moving the QWPs manually, polarization was alternately adjusted for best and worst BER. Worst-case BER changes were transformed into changes of Q^2 (in decibel) and are depicted in Fig. 5. The penalty reaches 2.3 dB for a differential group delay of 2.4 ps.

Next, robustness against fast polarization changes was tested. The $4 \times$ QWP-HWP- $4 \times$ QWP formation of the polarization scrambler generates polarization circles with changing orientations and sizes on the Poincaré sphere. Mean scrambling speed is $\pi/4$ times the maximum speed. The BER was recorded several times with and without scrambling at different scrambling rates. Compared to [4], the clock speed of the digital-to-analog converters which generate the electrode voltages was increased from 1.25 to 10 MHz. By the broadened polarization dither

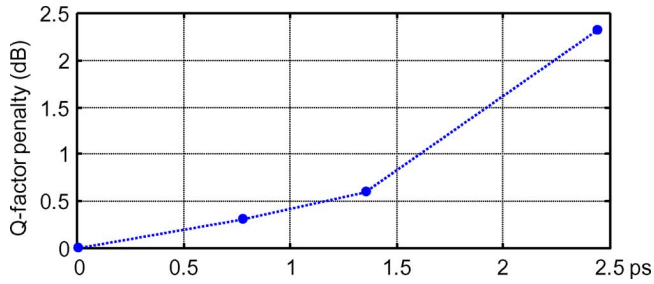

Fig. 5. Worst-case PMD penalty at $\text{BER} = 10^{-4}$ as a function of DGD.

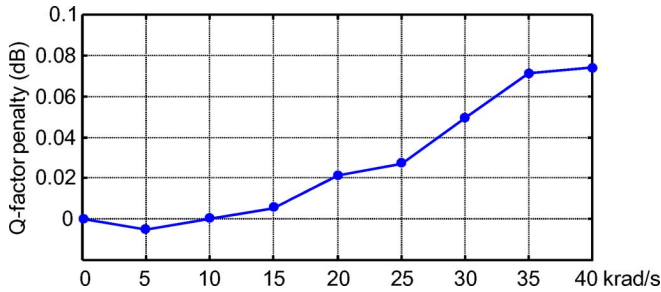

Fig. 6. Penalty at $\text{BER} = 10^{-4}$ as a function of maximum scrambling speed.

spectrum, tracking speed and control accuracy were improved. Fig. 6 shows Q -factor penalty as a function of maximum scrambling speed. Up to 10 krad/s, no scrambling penalty was observed. At the top scrambling speed of 40 krad/s, we measured a Q -factor penalty of ~ 0.08 dB. Operation was stable, without polarization channel jumps.

At last, the fiber spans were inserted into the transmission setup. Two more slow (~ 100 rad/s) scramblers were inserted before the second and the third span. The purpose here was to cause various PMD scenarios between the best and worst case. The system was operated during 289 min at 40-krad/s maximum (31.4-krad/s average) scrambling speed. The tracked polarization trajectory length is calculated as 545 Mrad. BER was recorded in 1-s intervals and is shown in Fig. 7 as a function of time. As mentioned, automatic pattern resynchronization was deactivated in order to detect any polarization channel jumps, which would lead to a BER overflow. But BER stayed well within a forward-error correction (FEC) limit. Observed fluctuations, within about a decade, may partly be due to an unreliable driver (not shown) of our RZ modulator. The system worked also successfully (within FEC limit) in many (= all tested) fixed positions of the slow PMD scramblers. After the transmission experiments, the mean DGD of the transmission link was determined as 0.9 ps.

IV. CONCLUSION

We have demonstrated PDM-RZ-DQPSK transmission, robust against fast polarization changes. With 4 bits per symbol, 200 Gb/s were transmitted in real-time on a single carrier. A polarization splitter allowed us to recover both polarization

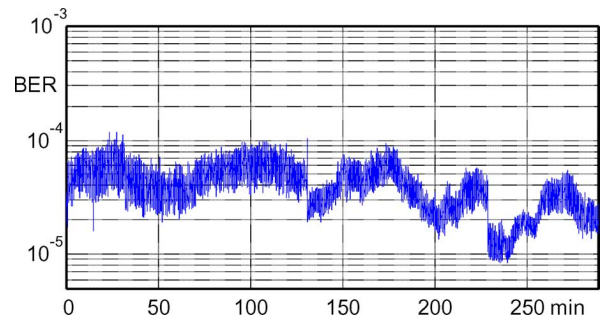

Fig. 7. BER performance while transmitting over 430 km during almost 5 h with 40-krad/s polarization scrambling rate.

channels even though there was only one polarization controller. BER stayed within FEC threshold while transmitting over 430 km of fiber at a record polarization scrambling speed of 40 krad/s. This shows the usability of interferometric direct detection for polarization-multiplexed transmission.

REFERENCES

- [1] H. Sun, K.-T. Wu, and K. Roberts, "Real-time measurements of a 40 Gb/s coherent system," *Opt. Express*, vol. 16, pp. 873–879, Jan. 2008.
- [2] M. Salsi *et al.*, "155 \times 100 Gbit/s coherent PDM-QPSK transmission over 7,200 km," in *Proc. ECOC 2009*, Vienna, Austria, Sep. 20–24, , Paper PD 2.5.
- [3] P. J. Winzer, A. H. Gnauck, G. Raybon, M. Schnecker, and P. J. Pupalaiakis, "56-Gbaud PDM-QPSK: Coherent detection and 2,500-km transmission," in *Proc. ECOC 2009*, Vienna, Austria, Sep. 20–24, , Paper PD 2.7.
- [4] B. Koch, R. Noé, D. Sandel, V. Mirvoda, V. Filsinger, and K. Puntari, "200-Gb/s, 430-km PDM-RZ-DQPSK (4 Bit/Symbol) transmission with 10 krad/s endless polarization tracking," in *Proc. OFC/NFOEC 2010*, San Diego, CA, Mar. 21–25, 2010, Paper OThD4.
- [5] R. Noé, B. Koch, V. Mirvoda, A. Hidayat, and D. Sandel, "38 krad/s, 3.8 Grad, broadband endless optical polarization tracking using LiNbO_3 device," *IEEE Photon. Technol. Lett.*, vol. 21, no. 17, pp. 1220–1222, Sep. 1, 2009.
- [6] R. Noé, B. Koch, V. Mirvoda, and D. Sandel, "Endless optical polarization control and PMD compensation," in *Proc. OFC/NFOEC 2010*, San Diego, CA, Mar. 21–25, 2010, Paper OThJ1.
- [7] S. Bhandare *et al.*, "5.94 Tbit/s, 1.49 bit/s/Hz ($40 \times 2 \times 2 \times 40$ Gbit/s) RZ-DQPSK polarization division multiplex C -band transmission over 324 km," *IEEE Photon. Technol. Lett.*, vol. 17, no. 4, pp. 914–916, Apr. 2005.
- [8] M. Yagi, S. Satomi, and S. Ryu, "Field trial of 160-Gbit/s, polarization-division multiplexed RZ-DQPSK transmission system using automatic polarization control," in *Proc. OFC/NFOEC 2008*, San Diego, CA, Feb. 24–28, 2008, Paper OThT7.
- [9] T. Ito, S. Fujita, E. T. de Gabory, and K. Fukuchi, "Improvement of PMD tolerance for 110 Gb/s Pol-Mux RZ-DQPSK signal with optical Pol-Dmux using optical PMD compensation and asymmetric symbol-synchronous chirp," in *Proc. OFC/NFOEC 2009*, San Diego, CA, Mar. 22–26, 2009, Paper OThR5.
- [10] A. H. Gnauck *et al.*, "25.6-Tb/s WDM transmission of polarization-multiplexed RZ-DQPSK signals," *J. Lightw. Technol.*, vol. 26, no. 1, pp. 79–84, Jan. 1, 2008.
- [11] L. Cheng *et al.*, "8 \times 200-Gbit/s polarization-division multiplexed CS-RZ-DQPSK transmission over 1200 km of SSMF," in *Proc. OECC2009*, Hong Kong, China, Jul. 13–17, 2009, Paper ThLP80.
- [12] H. Wernz *et al.*, "112 Gb/s PolMux RZ-DQPSK with fast polarization tracking based on interference control," in *Proc. OFC/NFOEC 2009*, San Diego, CA, Mar. 22–26, 2009, Paper OTuN4.